



BRICK & BLOCK

Manufacturers Since 1868

Concrete Interlocking Pavers



NEW! Carbon Accent Pavers (Page 18)

McNear now offers an accent paver in a dramatic new color: Carbon! Available only in our Rectangle (8-1/4" x 5-1/2") shape, this unblended color is McNear's darkest, and can be had in 4 different textures: Cobblestone, Slatestone, Cobblestone Backside, and Slatestone Backside. Accent pavers are typically used as borders, where they add richness to a pavement's design.



NEW! EuroStones (Page 24)

EuroStones are the latest addition to our family of landscape products. Eurostones can be used to build seat walls, planters, firepits, stairs, and more. Their rustic smooth texture is gentle to the touch, and they come in color blends that match or complement the colors of our Concrete Interlocking Pavers.



VERY, VERY OLD!

Brick: The Other Interlocking Paver (Page 22)

They're not for everyone, but for those who want a driveway or patio that is both traditional and dramatic, nothing beats real Fired-Clay Brick! Bricks have been used for roads and pavements for thousands of years, and can be installed today by the same contractors who install Concrete Interlocking Pavers, using the same tools and methods.



Concrete Interlocking Pavers



The Romans perfected interlocking cobblestone pavements over 2000 years ago, and many of their roads are still in good shape. Today, Interlocking Pavers made from modern high-strength concrete are used in the same fashion to create beautiful and durable pavements.

McNear Interlocking Pavers are renowned for their rich color blends and beautiful finishes. Our pavers come in a myriad of colors, shapes, and stone textures, and are complemented by design details such as stair treads, pool copings and 1-Inch thick pavers.

Almost any paved surface could be an opportunity to use McNear Interlocking pavers. Common applications include driveways, patios, pathways, and pool areas. Unlike poured concrete and asphalt pavements, interlocking pavements remain flexible and create a beautiful and crack-proof surface.

Whether you prefer an Old World look or a clean, modern design, McNear Brick and Block has crafted interlocking pavers that fit your personal style.

Table of Contents

Slatestone	2-5
Slatestone Backside	6-7
Cobblestone	8-11
Cobblestone Backside	12-13
Belgian Cobble	14
Old County Cobblestone	15
Permeable Pavers	16-17
Carbon Accent Pavers	18
1-Inch Pavers	19
Bullnose Treads and Copings	20-21
Brick: The Other Interlocking Paver	22-23
EuroStone Landscape Blocks	24-25
Paver Patterns	28
Specifications and Packaging	29

Slatestone



Charcoal/Gray Slatestone

Slatestone

Slatestone's smooth, layered surface will add the beauty of natural stone to your driveway, patio, or walkway. Use up to four different paver shapes to create either complex or simple designs.

Pavers can be ordered in any of our colors, but for non-stock colors, there may be minimum order requirements and/or set-up charges. Contact our office for a quote.

Please refer to pages 28-29 for information on patterns, sizes and coverage. Permeable Slatestone is also available; see pages 16-17.



Napa Slatestone

Stock Colors



Charcoal / Gray



Charcoal / Tan



Lassen



Napa



Olivine



Tierra



Yosemite



Carbon



Olivine Slatestone



Tierra Slatestone



Napa Slatestone



Charcoal/Tan Slatestone



Charcoal/Gray Slatestone



Yosemite Slatestone

Slatestone Backside



Charcoal/Gray Slatestone Backside

Slatestone Backside

For those interested in a flatter paving surface than our Slatestone texture, we have a solution that has been hidden in plain sight: *Slatestone Backside*. This surface is achieved by installing Slatestone pavers upside-down, and exposing their “backsides”. While the Backside surfaces are substantially flat, they are not perfectly so: each paver reflects the subtle scars and wear from our production boards’ many years of use. And these pavers also go through a tumbling process that adds an additional patina of age.

Pavers can be ordered in any of our colors, but for non-stock colors, there may be minimum order requirements and/or set-up charges. Contact our office for a quote.

Please refer to pages 28-29 for information on patterns, sizes and coverage. Permeable Slatestone Backside is also available; see pages 16-17.



Charcoal/Gray Slatestone Backside

Stock Colors



Charcoal / Gray



Charcoal / Tan



Lassen



Napa



Olivine



Tierra



Yosemite



Carbon

SLATESTONE • SLATESTONE BACKSIDE • COBBLESTONE • COBBLESTONE BACKSIDE • PERMEABLE • BELGIAN COBBLE • OLD COUNTY COBBLE • BULLNOSE

Cobblestone



Charcoal/Tan Cobblestone

Cobblestone

With their natural appearance and traditional look and feel, *Cobblestone* pavers have been pleasing homeowners for decades. Clean lines with soft rounded edges, Cobblestone pavers peacefully blend into the natural beauty of any landscape.

Pavers can be ordered in any of our colors, but for non-stock colors, there may be minimum order requirements and/or set-up charges. Contact our office for a quote.

Please refer to pages 28-29 for information on patterns, sizes and coverage. Permeable Cobblestone is also available; see pages 16-17.



Yosemite Cobblestone

60" - 10"
PARAPET

Stock Colors



Charcoal / Gray



Charcoal / Tan



Lassen



Napa



Olivine



Tierra



Yosemite



Carbon

SLATESTONE • SLATESTONE BACKSIDE • COBBLESTONE • COBBLESTONE BACKSIDE • PERMEABLE • BELGIAN COBBLE • OLD COUNTY COBBLE • BULLNOSE



Yosemite Cobblestone



Napa Cobblestone



Tierra Cobblestone



Olivine Cobblestone



Charcoal/Gray Cobblestone



Napa & Charcoal/Gray Cobblestone

Cobblestone Backside



Yosemite Cobblestone Backside

Cobblestone Backside

For those interested in a flatter paving surface than our Cobblestone texture, we have a solution that has been hidden in plain sight: *Cobblestone Backside*. This surface is achieved by installing Cobblestone pavers upside-down, and exposing their “backsides”. While the Backside surfaces are substantially flat, they are not perfectly so: each paver still reflects the subtle scars and wear from our production boards’ many years of use. No two pavers are identically alike.

Pavers can be ordered in any of our colors, but for non-stock colors, there may be minimum order requirements and/or set-up charges. Contact our office for a quote.

Please refer to pages 28-29 for information on patterns, sizes and coverage. Permeable Cobblestone Backside is also available; see pages 16-17.



Lassen Cobblestone Backside

60" - 10"
PARAPET

Stock Colors



Charcoal / Gray



Charcoal / Tan



Lassen



Napa



Olivine



Tierra



Yosemite



Carbon

SLATESTONE • SLATESTONE BACKSIDE • COBBLESTONE • COBBLESTONE BACKSIDE • PERMEABLE • BELGIAN COBBLE • OLD COUNTY COBBLE • BULLNOSE

11" - 4" CMU
WORKING POINT

Belgian Cobble



Charcoal/Gray Belgian Cobble

Belgian Cobble

You might not live in Europe, but you can replicate that classic Old World appeal for your home. *Belgian Cobble's* timeworn texture radiates warmth and charm, and is available in four different paver sizes.

Please refer to pages 28-29 for information on patterns, sizes and coverage.

Pavers can be ordered in any of our colors, but for non-stock colors, there may be minimum order requirements and/or set-up charges. Contact our office for a quote.



Charcoal / Gray



Charcoal / Tan

Old County Cobblestone



Charcoal/Gray Old County Cobblestone

Old County Cobblestone

Capture the essence of ancient cobble streets curving through scenic villages. *Old County Cobblestone* can add a touch of serenity to any style of architecture whether you prefer a rustic or modern aesthetic.

Please refer to pages 28-29 for information on patterns, sizes and coverage.



Permeable Pavers

Available in Slatestone, Cobblestone and Canyon Cobble



Charcoal/Tan Permeable Cobblestone

Heal the earth while you beautify your home

McNear *Permeable Pavers* are engineered to support the water cycle. They reduce storm drain runoff and filter out water-borne pollutants as rain water is returned to the earth naturally.

Our Permeable Pavers incorporate the same aesthetic and design features as our standard interlocking pavers, using multiple shapes and small gaps to preserve their natural appeal.

- Save money by reducing or eliminating your need for storm drains or catch basins
- Recharge the aquifer and help increase supplies of local drinking water
- Improve the water quality of streams and creeks
- Reduce storm water runoff and flooding problems
- Work in harmony with your home's natural vegetation and landscaping
- Worry less with pavers that are both durable and earth-friendly.



Charcoal/Gray Permeable Cobblestone



Olivine Permeable Cobblestone

Pavers can be ordered in any of our colors, but for non-stock colors, there may be minimum order requirements and/or set-up charges. Contact our office for a quote.

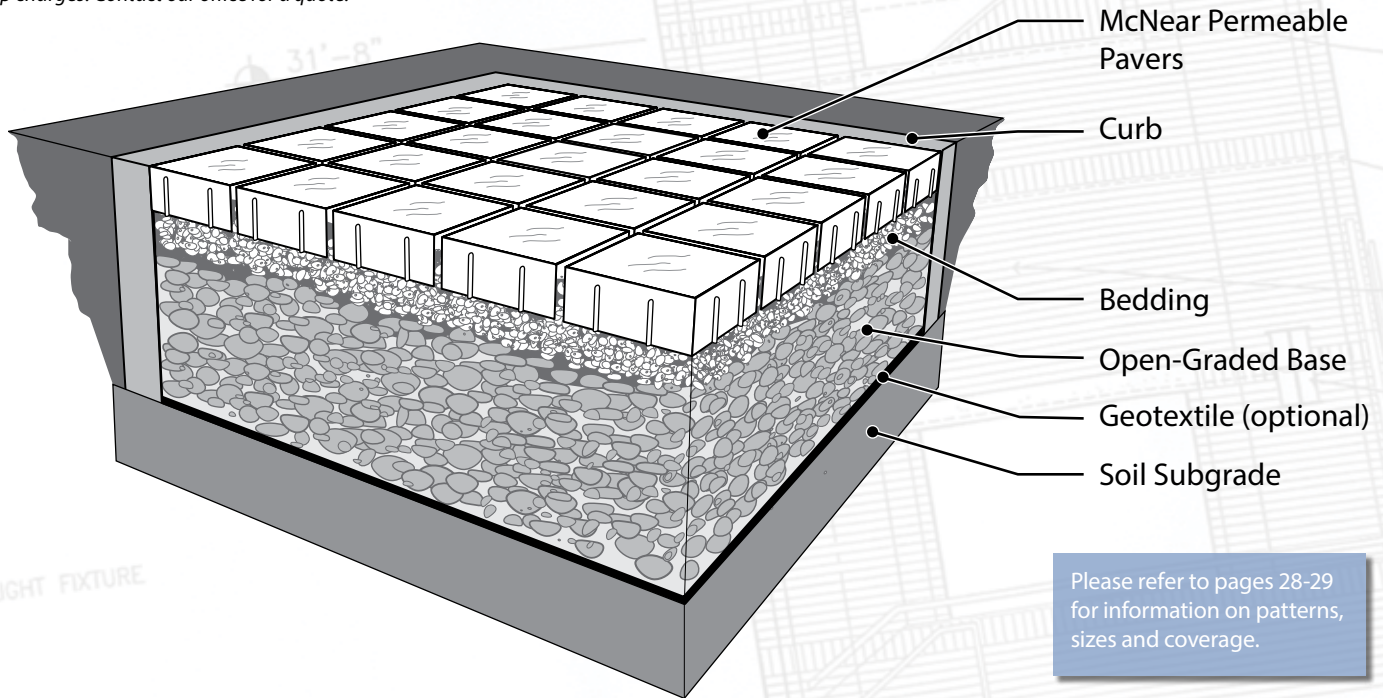

Please refer to pages 28-29 for information on patterns, sizes and coverage.

Permeable Pavers can be ordered in any color of Slatestone, Slatestone Backside, Cobblestone, and Cobblestone Backside, however we do not stock any Permeable Pavers, and minimum orders may apply.

Carbon Accent Pavers

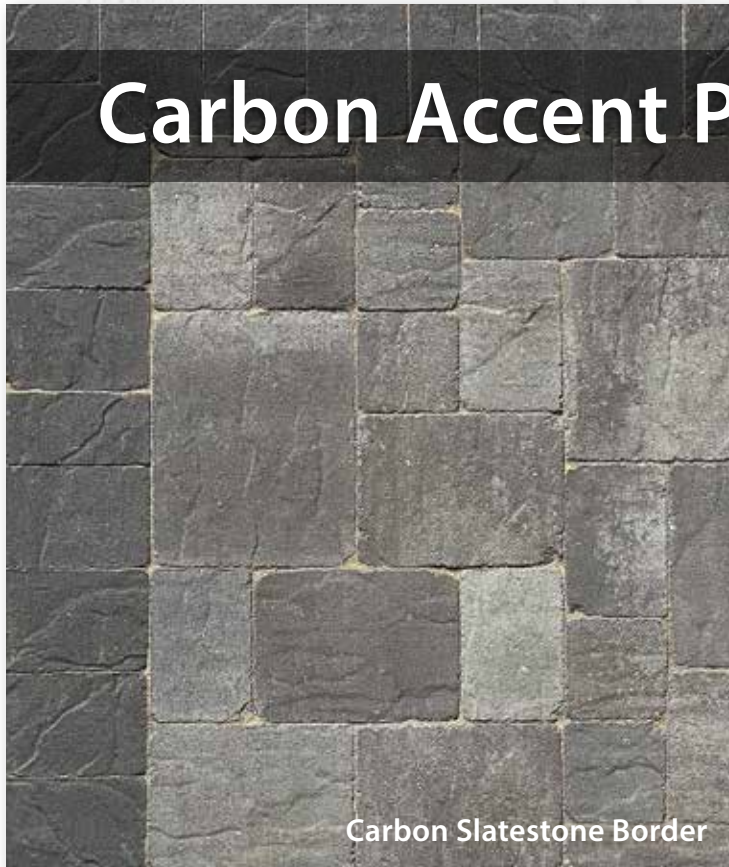

Carbon Slatestone Border

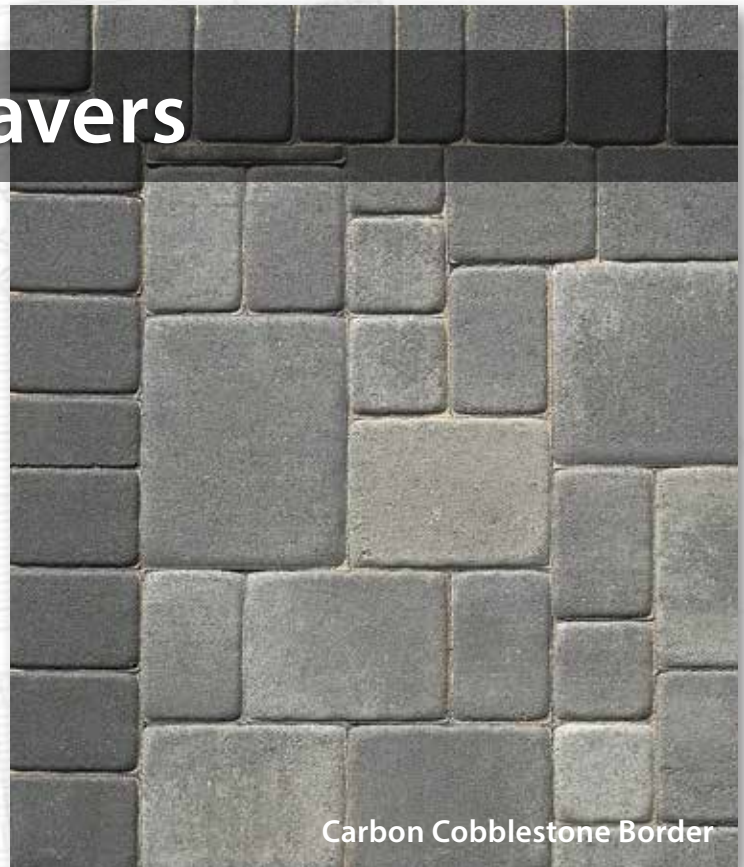

Carbon Cobblestone Border

Carbon Accent Pavers

McNear now offers an accent paver in a dramatic new color: Carbon! Available only in our Rectangle (8-1/4 x 5-1/2) shape, this unblended color is McNear's darkest, and can be had in 4 different textures: Cobblestone, Slatestone, Cobblestone Backside, and Slatestone Backside. Accent pavers are typically used as borders, where they add richness to a pavement's design.



1-Inch Pavers

McNear 1-Inch Pavers are ideal for applications where full-depth pavers are impractical. Use them to cover existing porches and stairs, and to face concrete curbs and gutters. McNear 1-Inch Pavers can be installed using either mortar or sand-set techniques.

1-Inch pavers can be ordered in any of our shapes, styles and colors, including Bullnose pieces. Custom thicknesses are also available.

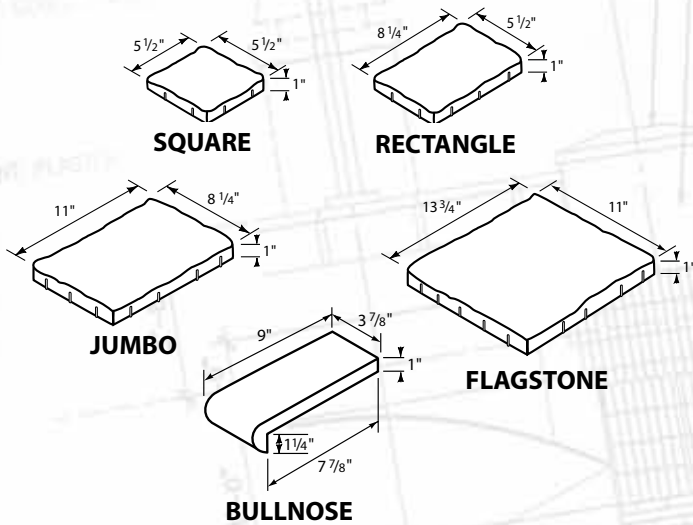

Bullnose Treads & Copings



Bullnose

The ideal finisher to your landscaping—our *Bullnose Pavers* complement any McNear product while adding a polished look to your stairway, driveway, pathway, or swimming pool.

Bullnose pavers are available in Classic and Weathered textures. McNear's Classic texture retains a smooth, contemporary surface. If you prefer rustic landscaping, our Weathered texture is tumbled to create a rough yet charming, time worn feel.



Charcoal / Gray (*Classic*)



Charcoal / Tan (*Weathered*)

Call for availability of specific colors.



SLATESTONE • SLATESTONE BACKSIDE • COBBLESTONE • COBBLESTONE BACKSIDE • PERMEABLE • BELGIAN COBBLE • OLD COUNTY COBBLE • BULLNOSE

Brick: The Other Interlocking Paver



Brick: The Other Interlocking Paver

The use of Concrete Interlocking Pavers has exploded in recent years, and they are now commonplace in driveways and patios almost everywhere. But people overlook the other interlocking paver that has been in use since the days of the Roman empire: Fired Clay Bricks.

Clay Bricks have some significant advantages over concrete pavers: they are available in a broader range of colors, their colors are far more vibrant, and their colors can be richly variegated.

The Bricks of McNear's Sandmold Series and Old California Series are particularly well-suited for use in interlocking pavements. Their relieved edges and rustic nature allows them to be easily installed without concerns about chipping. The same contractors who install Concrete Interlocking Pavers, can install McNear's Clay Bricks, using the same tools and methods. For driveways, use our Standard Solid size Bricks, which are 2-7/16" thick. Our Split size Bricks (1-1/4" thick) are great for use as interlocking pavers in pedestrian areas, although they should not be used for areas with vehicular traffic.

If you want something a little out of the ordinary, or if your project has an historic or Old World feel, then consider using one of McNear's many brick choices as your interlocking pavement.

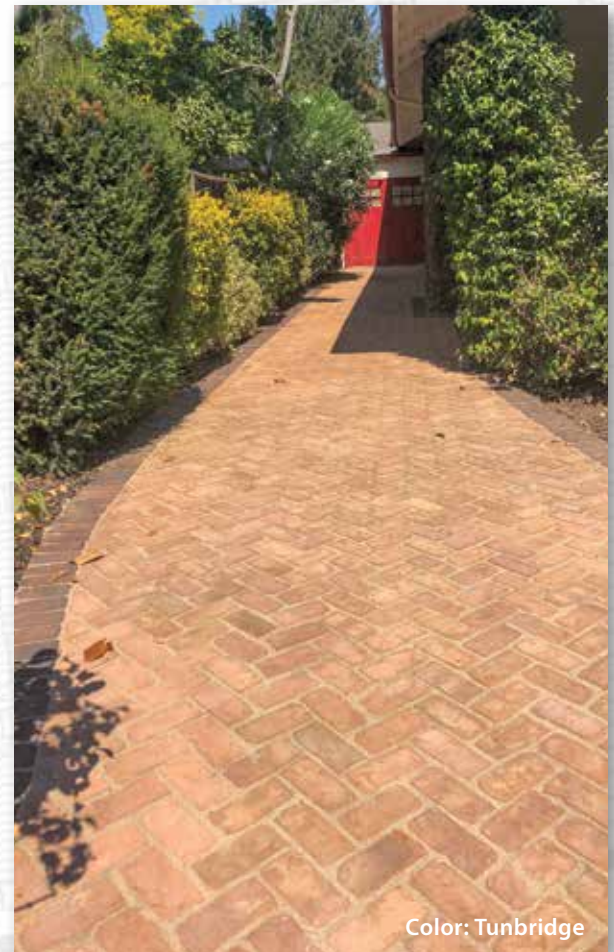



Color: Embarcadero



Color: Santa Fe



Color: Chicago Common

EuroStone Landscape Blocks



EuroStones

EuroStones are modular concrete landscaping blocks, designed for building common outdoor structures such as seating walls, steps and stairs, garden planters, columns, fire pits, and more. Using modern high-strength concrete adhesives, EuroStones create beautiful and durable landscape feature in a fraction of the time needed for other construction methods, and at a fraction of the cost.

These multicolored blocks are put through McNear's unique aging process, which replicates the chipped edges, broken corners and general wear of ancient stone walls, and which gives them a smooth, but rusticated texture that is gentle to the touch. EuroStones are available in 8 colors that correspond to McNear's Interlocking Paver colors: Carbon, Charcoal/Gray, Charcoal/Tan, Lassen, Napa, Olivine, Tierra, and Yosemite.



60°-10°
PARAPET

Stock Colors



SLATESTONE • SLATESTONE BACKSIDE • COBBLESTONE • COBBLESTONE BACKSIDE • PERMEABLE • BELGIAN COBBLE • OLD COUNTY COBBLE • BULLNOSE



Napa Permeable Cobblestone



Lassen Cobblestone

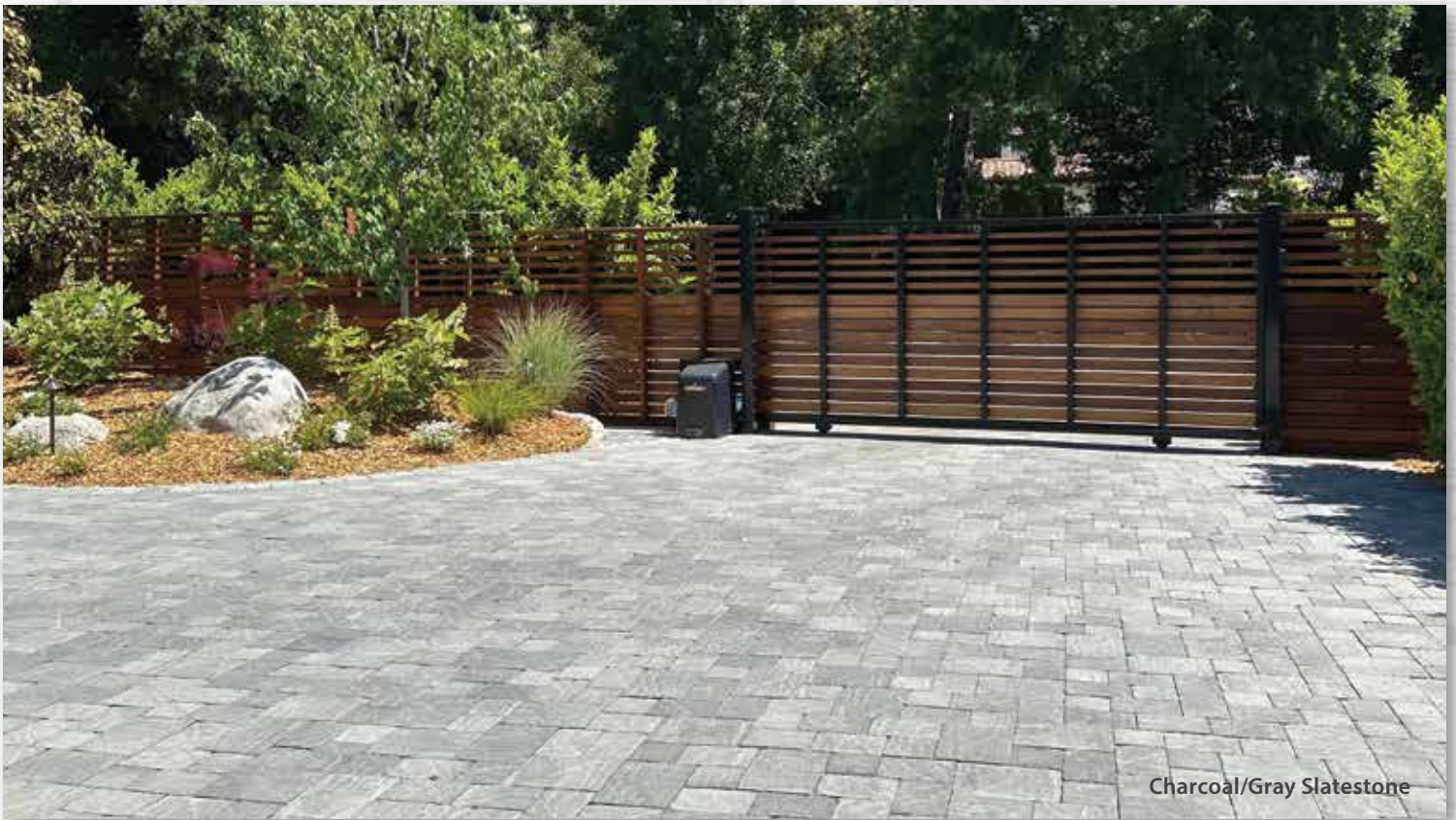

Charcoal/Gray Slatestone



Yosemite Cobblestone



Napa Slatestone



Tierra Cobblestone

Paver Patterns

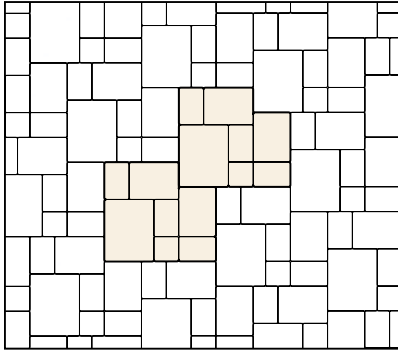

DIAMOND VERTIGO
 30% FLAGSTONE* 27% RECTANGLE
 36% JUMBO 6% SQUARE

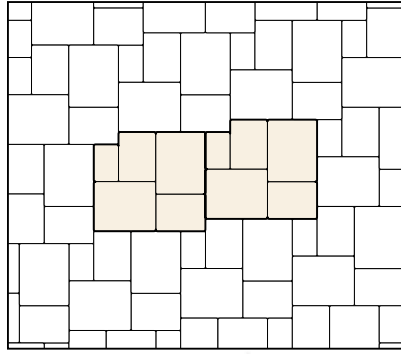

EL DORADO
 57% FLAGSTONE* 9% RECTANGLE
 34% JUMBO

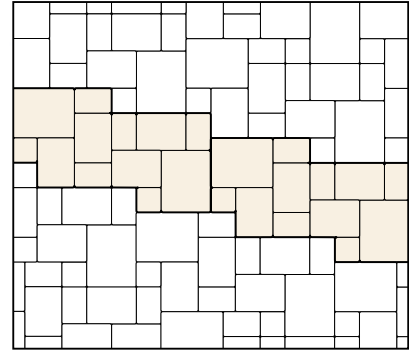

ESCALATOR
 33% FLAGSTONE* 20% RECTANGLE
 40% JUMBO 7% SQUARE

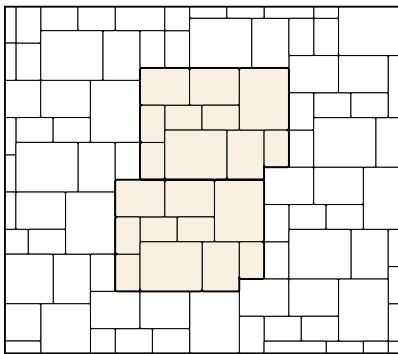

GALANT
 38% FLAGSTONE* 28% RECTANGLE
 34% JUMBO

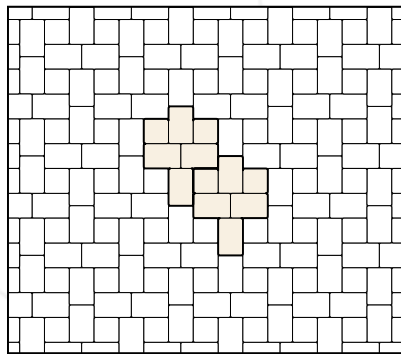

OLD TOWN
 75% RECTANGLE
 25% SQUARE

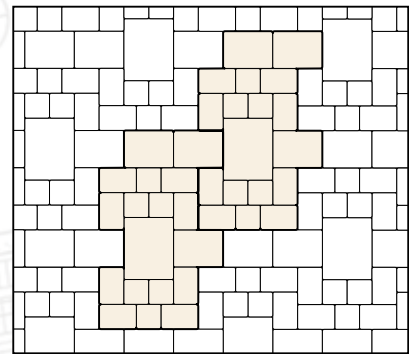

OLD WORLD
 16% FLAGSTONE* 38% RECTANGLE
 28% JUMBO 19% SQUARE

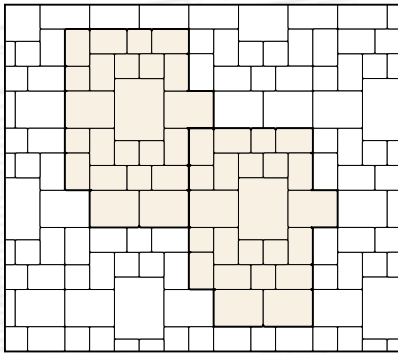

OLD WORLD II
 12% FLAGSTONE* 38% RECTANGLE
 30% JUMBO 20% SQUARE

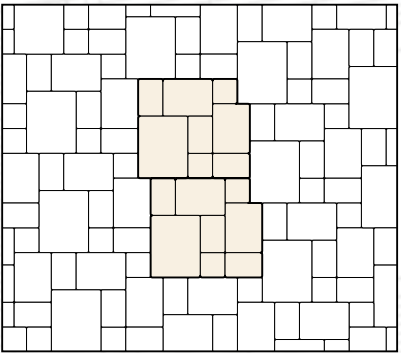

SHAKE
 28% FLAGSTONE* 26% RECTANGLE
 34% JUMBO 11% SQUARE

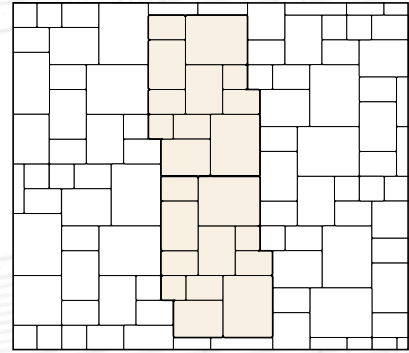

SILVER DRY
 37% FLAGSTONE* 22% RECTANGLE
 33% JUMBO 7% SQUARE

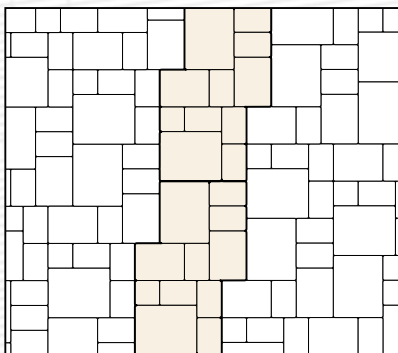

SPLIT ARROW
 38% FLAGSTONE* 35% RECTANGLE
 23% JUMBO 4% SQUARE

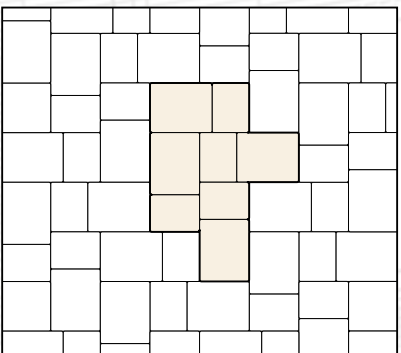

TOPAZ
 62% FLAGSTONE*
 38% JUMBO

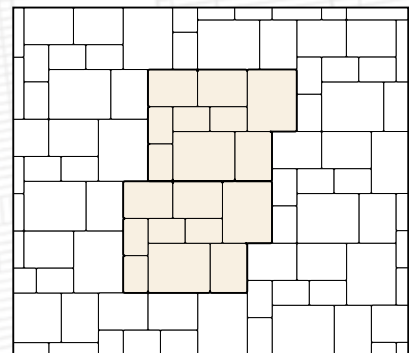

TRINITY
 40% FLAGSTONE* 24% RECTANGLE
 36% JUMBO

Specifications & Packaging

PAVER SHAPES

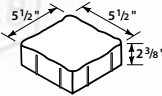

SQUARE

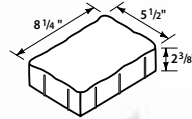

RECTANGLE

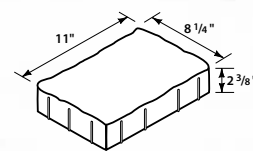

JUMBO

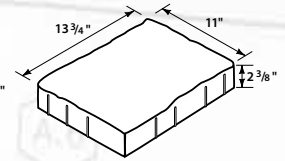

FLAGSTONE

SLATESTONE

Slatestone Backside, Belgian Cobble, Old County Cobble

Height	2-3/8" (60 MM) OR 3-1/8" (80 MM)			
Width	5-1/2"	5-1/2"	8-1/4"	11"
Length	5-1/2"	8-1/4"	11"	13-3/4"
Coverage	4.74 PCS/SF	3.17 PCS/SF	1.58 PCS/SF	0.95 PCS/SF
Weight				
60 MM	5.6 LBS.	8.5 LBS	17.9 LBS	29.5 LBS
80 MM	7.5 LBS.	11.5 LBS	23.0 LBS	38.5 LBS
Pallet Quantity				
60 MM	560 PCS.	350 PCS	176 PCS	99 PCS
80 MM	384 PCS.	240 PCS	129 PCS	72 PCS
Pallet Coverage				
60 MM	118 SF	110 SF	111 SF	104 SF
80 MM	81SF	76 SF	76 SF	69 SF
Pallet Wt. (approx)				
60 MM	2,960 LBS.	2770	2670	2680
80 MM	2,930 LBS.	2810	2810	2790

COBBLESTONE

Pallet Quantity				
60 MM	480 PCS	300 PCS	160 PCS	99 PCS
80 MM	384 PCS	240 PCS	120 PCS	72 PCS
Pallet Coverage				
60 MM	101 SF	95 SF	101 SF	104 SF
80 MM	81 SF	76 SF	76 SF	69 SF
Pallet Wt. (approx)				
60 MM	2690 LBS.	2450 LBS	2690 LBS	2680 LBS
80 MM	2930 LBS.	2810 LBS	2810 LBS	2790 LBS

*80MM Pavers are Non-Stock, and only available in Cobblestone, Cobblestone Backside, Slatestone, and Slatestone Backside. Call for availability.

Colors: Cobblestone, Cobblestone Backside, Slatestone, and Slatestone Backside are available in these colors: Carbon (Rectangles Only), Charcoal/Gray, Charcoal/Tan, Lassen, Napa, Olivine, Tierra, and Yosemite.

Belgian Cobble and Old County Cobble are available in Charcoal/Gray and Charcoal/Tan.

BULLNOSE PAVERS

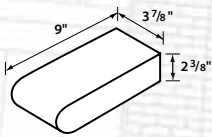

CLASSIC

Height	2-3/8" (60 MM)
Width	3-7/8" (98 MM)
Length	9" (227 MM)
Coverage	3.1 PCS/LIN FT
Weight	6.75 LBS
Pallet Quantity	300 PCS
Pallet Coverage	97 SF
Pallet Weight	2,085 LBS

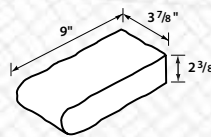

WEATHERED

Height	2-3/8" (60 MM)
Width	3-7/8" (98 MM)
Length	9" (227 MM)
Coverage	3.1 PCS/LIN FT
Weight	6.75 LBS
Pallet Quantity	425 PCS
Pallet Coverage	137 SF
Pallet Weight	2,930 LBS

1-INCH PAVERS

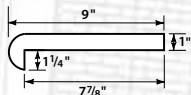

BULLNOSE

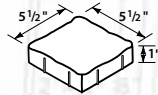

SQUARE

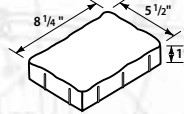

RECTANGLE

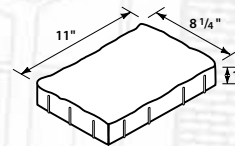

JUMBO

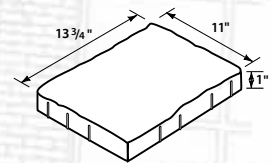

FLAGSTONE

Composition & Manufacture: McNear pavers are manufactured from a high strength concrete mix. They conform to ASTM C-936 and have a minimum average compressive strength of 8,000 PSI.

Visit www.mcnear.com to see our newest products and colors.

Beauty and Sustainability

When we opened our doors in 1868, our workers made bricks by hand and used wheelbarrows to load them onto scow schooners for delivery to the many small ports lining San Francisco Bay.

The days of horse and sail are long gone, but the landmarks built with our products, such as Ghirardelli Square and the Golden Gate Bridge, remain.

Today we manufacture many more products than the clay bricks we started with. McNear is now a leading regional manufacturer of Interlocking Pavers, as well as the VERSA-LOK® family of Segmental Retaining Walls.



See Our Other Lines of McNear Products

Visit us online at www.mcnear.com to download or request brochures and samples, and to see our newest colors and products.

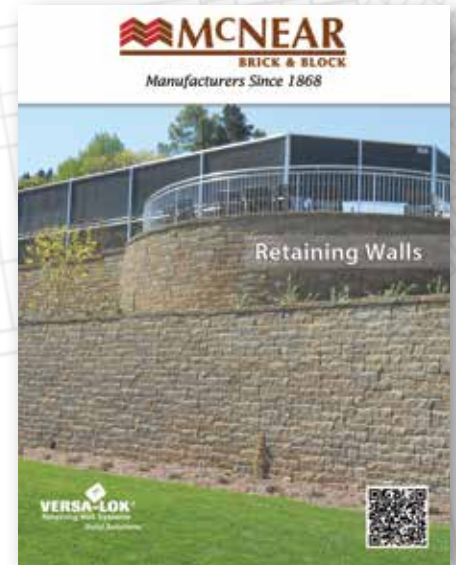
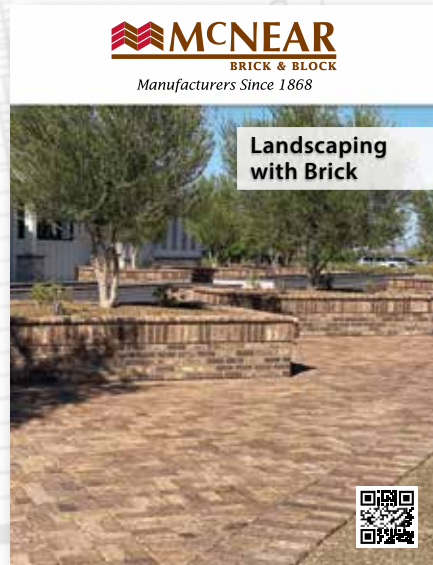
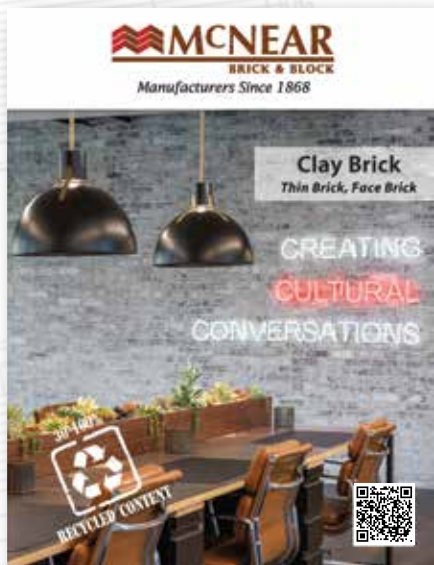

- Thin Brick
- Face Brick
- Interlocking Pavers
- VERSA-LOK® Retaining Walls



1 McNear Brickyard Rd., San Rafael, CA 94901

Phone: 415-454-6811
Fax: 415-257-6353
E-mail: sales@mcnear.com
www.mcnear.com